

# DH-HAC-HDW1500TRQ(-A)

## 5MP Starlight HDCVI Quick-to-install IR Eyeball Camera



\* The parameters and datasheets below can only be applied to 1500-S2 series.

- Max 25 fps@5MP (16:9 video output)
- Quick-to-install eyeball saves installation time
- Built-in mic (-A)
- CVI/CVBS/AHD/TVI switchable
- 3.6 mm fixed lens (2.8 mm optional)
- Max. IR length 25 m, Smart IR
- IP50, DC12V



### System Overview

Experience 5MP full HD video and the simplicity of using existing cabling infrastructure with HDCVI. The Lite series 5MP HDCVI camera features a compact design and offers a high quality image at a friendly price. It offers various motorized/fixed lens models with a multi-language OSD and HD/SD switchable output. Its structural flexibility and high cost-performance makes the camera an ideal choice for SMB solutions.

### Functions

#### 4 Signals over 1 Coaxial Cable

HDCVI technology supports 4 signals to be transmitted over 1 coaxial cable simultaneously, i.e. video, audio\*, data and power. Dual-way data transmission allows the HDCVI camera to interact with the XVR, such as sending control signal or triggering alarm. Moreover, HDCVI technology supports PoC for construction flexibility.

\* Audio input is available for some models of HDCVI cameras.

#### Easy Installation

HDCVI Quick-to-install eyeball adopts quick-to-install pedestal, which can achieve easier installation than conventional eyeball. Quick-to-install camera reduces time and labor costs.

#### Long Distance Transmission

HDCVI technology guarantees real-time transmission at long distance without any loss. It supports up to 700 m for 5MP HD video via coaxial cable, and up to 300 m via UTP cable.\*

\*Actual results verified by real-scene testing in Dahua's test laboratory.

#### Simplicity

HDCVI technology inherits the feature of simplicity from traditional analog surveillance system, making itself a best choice for investment protection. HDCVI system can seamlessly upgrade the traditional analog system without replacing existing coaxial cabling. The plug and play approach enables full HD video surveillance without the hassle of configuring a network.

#### Smart IR

The camera is designed with IR LED illumination for best lowlight performance. Smart IR is a technology that ensures brightness uniformity in B/W image under low illumination. Dahua's unique Smart IR adjusts to the intensity of camera's infrared LEDs to compensate for the distance of an object, and prevents IR LEDs from overexposing images as the object come closer to the camera.

#### Multi-formats

The camera supports multiple video formats including HDCVI, CVBS and other two common HD analog formats in the market. The four formats can be switched over through OSD menu. This feature makes the camera to be compatible with most end users' existing HD/SD DVRs.







#### Multi-language OSD

OSD menu provides multiple image adjustments and function settings to meet the requirements of different monitoring scenes. The OSD menu includes configurations such as backlight mode, day/night, white balance, privacy mask and motion detect. The camera supports 11 languages for OSD menu, namely, Chinese, English, French, German, Spanish, Portuguese, Italian, Japanese, Korean, Russian and Polish.

#### Protection

With working temperature range of -40°C to +50°C (-40°F to 122°F), the camera is designed for extreme temperature environments. Supporting  $\pm 30\%$  input voltage tolerance, this camera suits even the most unstable power supply conditions. Its 4KV lightning rating provides protection against the camera and its structure from the effects of lightning.

| Technical Specification    |  |                      |                     |                     |                   |
|----------------------------|--|----------------------|---------------------|---------------------|-------------------|
| <b>Camera</b>              |  |                      |                     |                     |                   |
| Image Sensor               | 1/2.7 inch CMOS  |                      |                     |                     |                   |
| Max. Resolution            | 2880 (H) × 1620 (V)  |                      |                     |                     |                   |
| Pixel                      | 5MP  |                      |                     |                     |                   |
| Scanning System            | Progressive  |                      |                     |                     |                   |
| Electronic Shutter Speed   | PAL: 1/25s–1/100000s<br>NTSC: 1/30s–1/100000s  |                      |                     |                     |                   |
| S/N Ratio                  | >65 dB   |                      |                     |                     |                   |
| Min. Illumination          | 0.01 Lux/F1.6 30IRE, 0 Lux IR on   |                      |                     |                     |                   |
| Illumination Distance      | 25m (82.0 ft)  |                      |                     |                     |                   |
| Illuminator On/Off Control | Auto; manual   |                      |                     |                     |                   |
| Illuminator Number         | 2  |                      |                     |                     |                   |
| Pan/Tilt/Rotation Range    | Pan: 0°–360°<br>Tilt: 0°–78°<br>Rotation: 0°–360°  |                      |                     |                     |                   |
| <b>Lens</b>                |  |                      |                     |                     |                   |
| Lens Type                  | Fixed-focal  |                      |                     |                     |                   |
| Mount Type                 | M12  |                      |                     |                     |                   |
| Focal Length               | 2.8 mm; 3.6 mm   |                      |                     |                     |                   |
| Max. Aperture              | F1.6   |                      |                     |                     |                   |
| Field of View              | 2.8 mm: 132° × 111° × 58°<br>(diagonal × horizontal × vertical)<br>3.6 mm: 109° × 92° × 48°<br>(diagonal × horizontal × vertical)  |                      |                     |                     |                   |
| Iris Type                  | Fixed iris   |                      |                     |                     |                   |
| Close Focus Distance       | 2.8 mm: 0.9 m (3.0 ft)<br>3.6 mm: 1.6 m (5.2 ft)   |                      |                     |                     |                   |
| DORI Distance              | Lens   | Detect               | Observe             | Recognize           | Identify          |
|                            | 2.8 mm   | 63.6 m<br>(208.7 ft) | 25.4 m<br>(83.3 ft) | 12.7 m<br>(41.7 ft) | 6.4 m<br>(21.0ft) |
|                            | 3.6 mm   | 80 m<br>(262.5 ft)   | 32 m<br>(105.0 ft)  | 16 m<br>(52.5 ft)   | 8 m<br>(26.2 ft)  |
| <b>Video</b>               |  |                      |                     |                     |                   |
| Frame Rate                 | CVI:<br>PAL: 5M@25 fps; 4M@25 fps; 1080P@25 fps;<br>NTSC: 5M@25 fps; 4M@30 fps; 1080P@30 fps<br>AHD:<br>PAL: 4M@25 fps;<br>NTSC: 4M@30 fps<br>TVI:<br>PAL: 4M@25 fps;<br>NTSC: 4M@30 fps<br>CVBS:<br>PAL: 960H;<br>NTSC: 960H                |                      |                     |                     |                   |
| Resolution                 | 5M (2880 × 1620); 4M (2560 × 1440); 1080P (1920 × 1080); 960 H (960 × 576/960 × 480)   |                      |                     |                     |                   |
| Day/Night                  | Auto switch by ICR   |                      |                     |                     |                   |
| BLC                        | BLC/HLC/DWDR   |                      |                     |                     |                   |
| WDR                        | DWDR   |                      |                     |                     |                   |
| White Balance              | Auto; manual   |                      |                     |                     |                   |
| Gain Control               | Auto; manual   |                      |                     |                     |                   |
| Noise Reduction            | 2D NR  |                      |                     |                     |                   |
| Smart IR                   | Yes  |                      |                     |                     |                   |
| Mirror                     | Off/On   |                      |                     |                     |                   |
| Privacy Masking            | Off/On (8 area, rectangle)   |                      |                     |                     |                   |
| <b>Certifications</b>      |  |                      |                     |                     |                   |
| Certifications             | CE (EN 55032:2015, EN 61000-3-2:2014, EN 61000-3-3:2013, EN 55024:2010+A1:2015, EN 55035:2017, EN 50130-4:2011+A1:2014, EN 62368-1:2014+A11:2017) FCC (CFR 47 FCC Part 15 subpartB, ANSI C63.4-2014) UL (UL60950-1+CAN/CSA C22.2 No.60950-1) |                      |                     |                     |                   |
| <b>Port</b>                |  |                      |                     |                     |                   |
| Video Output               | Video output choices of CVI/TVI/AHD/CVBS by one BNC port   |                      |                     |                     |                   |
| Audio Interface            | One channel built-in mic (-A)  |                      |                     |                     |                   |
| <b>Power</b>               |  |                      |                     |                     |                   |
| Power Supply               | 12V ±30% DC  |                      |                     |                     |                   |
| Power Consumption          | Max 3.0W (12V DC, IR on)   |                      |                     |                     |                   |
| <b>Environment</b>         |  |                      |                     |                     |                   |
| Operating Temperature      | -40°C to +50°C (-40°F to 122°F); <95% (non-condensation)   |                      |                     |                     |                   |
| Storage Temperature        | -40°C to +50°C (-40°F to 122°F); <95% (non-condensation)   |                      |                     |                     |                   |
| Protection Grade           | IP50   |                      |                     |                     |                   |
| <b>Structure</b>           |  |                      |                     |                     |                   |
| Casing                     | Plastic  |                      |                     |                     |                   |
| Dimensions                 | Φ97.1 mm × 93.0 mm (Φ3.82" × 3.66")  |                      |                     |                     |                   |
| Net Weight                 | 0.17 kg (0.37lb)   |                      |                     |                     |                   |
| Gross Weight               | 0.23 kg (0.51lb)   |                      |                     |                     |                   |

| Ordering Information |                             |   | Accessories   |   |   |
|----------------------|-----------------------------|---|---|---|---|
| Type                 | Part Number                 | Description                               | Optional:   |   |   |
| SMP Camera           | DH-HAC-HDW1500TRQP 2.8 mm   | 5MP HDCVI IR Eyeball Camera, PAL          |  |  |  |
|                      | DH-HAC-HDW1500TRQP 3.6 mm   |   | PFA13G<br>Junction Box  | PFB205W<br>Wall Mount Bracket   | PFA152-E<br>Pole Mount Bracket<br>(For use with PFB205W)                            |
|                      | DH-HAC-HDW1500TRQN 2.8 mm   | 5MP HDCVI IR Eyeball Camera, NTSC         |  |  |  |
|                      | DH-HAC-HDW1500TRQN 3.6 mm   |   | PFM800-4K<br>Passive HDCVI Balun  | PFM321D<br>12V 1A Power Adapter   | PFM904<br>Integrated Mount Tester   |
|                      | DH-HAC-HDW1500TRQP-A 2.8 mm | 5MP HDCVI IR Eyeball Camera, PAL          |   |   |   |
|                      | DH-HAC-HDW1500TRQP-A 3.6 mm |   |   |   |   |
|                      | DH-HAC-HDW1500TRQN-A 2.8 mm | 5MP HDCVI IR Eyeball Camera, NTSC         |   |   |   |
|                      | DH-HAC-HDW1500TRQN-A 3.6 mm |   |   |   |   |
| Accessories          | PFA13G                      | Junction Box                              |   |   |   |
|                      | PFB205W                     | Wall Mount Bracket                        |   |   |   |
|                      | PFA152-E                    | Pole Mount Bracket (For use with PFB205W) |   |   |   |
|                      | PFM800-4K                   | Passive HDCVI Balun                       |   |   |   |
|                      | PFM321D                     | 12V 1A Power Adapter                      |   |   |   |
|                      | PFM904                      | Integrated Mount Tester                   |   |   |   |

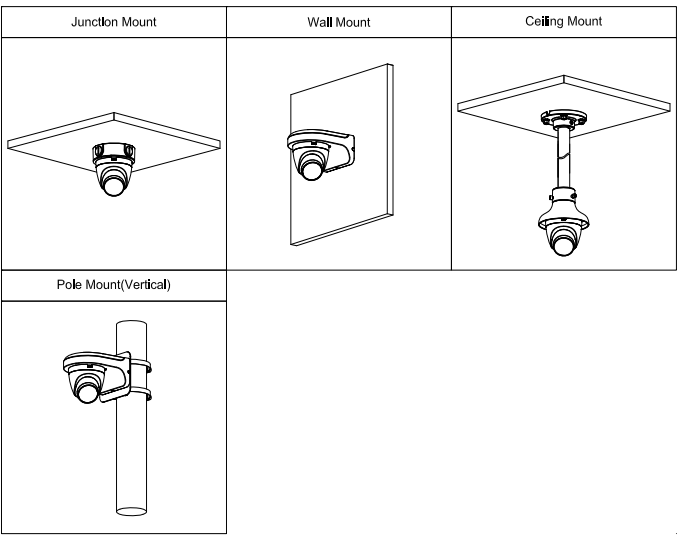

**Dimensions (mm[inch])**

